

### Features

- Fast Switching
- Improved dv/dt Capability
- Moisture Sensitivity Level 1
- Epoxy Meets UL 94 V-0 Flammability Rating
- Halogen Free Available Upon Request By Adding Suffix "-HF"
- Lead Free Finish/RoHS Compliant ("P" Suffix Designates RoHS Compliant. See Ordering Information)

### Maximum Ratings

- Operating Junction Temperature Range : -55°C to +175°C
- Storage Temperature Range : -55°C to +175°C
- Thermal Resistance : 1.76°C/W Junction to Case

Parameter	Symbol	Value	
Drain-source Voltage	$V_{DS}$	60V	
Gate-source Voltage	$V_{GS}$	±20V	
Drain Current	$I_D$	$T_C=25^\circ\text{C}$	80A
		$T_C=100^\circ\text{C}$	56A
Pulsed Drain Current	$I_{DM}$	240A	
Power Dissipation	$P_D$	68W	
Single Pulsed Avalanche Energy <sup>(1)</sup>	$E_{AS}$	225mJ	

Note: 1.  $E_{AS}$  Condition:  $T_j=25^\circ\text{C}$ ,  $V_{DD}=30\text{V}$ ,  $V_G=10\text{V}$ ,  $L=0.5\text{mH}$ ,  $R_g=25\Omega$

### Internal Structure

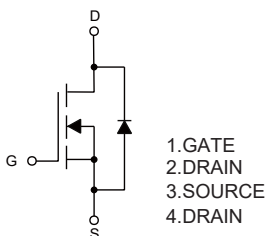

## N-CHANNEL MOSFET

### DPAK

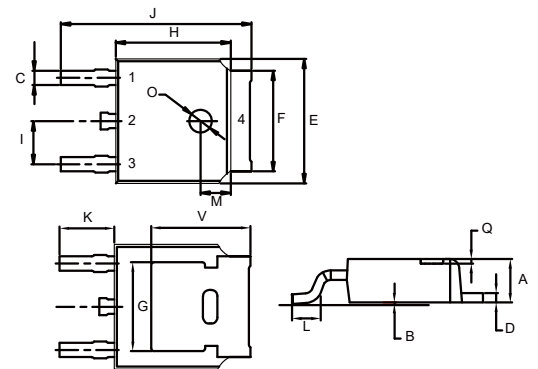

DIM	INCHES		MM		NOTE
	MIN	MAX	MIN	MAX	
A	0.087	0.094	2.20	2.40	
B	0.000	0.005	0.00	0.13	
C	0.026	0.034	0.66	0.86	
D	0.018	0.023	0.46	0.58	
E	0.256	0.264	6.50	6.70	
F	0.201	0.215	5.10	5.46	
G	0.190		4.83		TYP.
H	0.236	0.244	6.00	6.20	
I	0.086	0.094	2.18	2.39	
J	0.386	0.409	9.80	10.40	
K	0.114		2.90		TYP.
L	0.055	0.067	1.40	1.70	
M	0.063		1.60		TYP.
O	0.043	0.051	1.10	1.30	
Q	0.000	0.012	0.00	0.30	
V	0.211		5.35		TYP.

**ELECTRICAL CHARACTERISTICS (Ta=25°C unless otherwise specified)**

Parameter	Symbol	Condition	Min	Typ	Max	Unit
<b>Off Characteristics</b>						
Drain-Source Breakdown Voltage	$BV_{DSS}$	$V_{GS}=0V, I_D=250\mu A$	60	-	-	V
Zero Gate Voltage Drain Current	$I_{DSS}$	$V_{DS}=60V, V_{GS}=0V$	-	-	1	$\mu A$
Gate-Body Leakage Current	$I_{GSS}$	$V_{GS}=\pm 20V, V_{DS}=0V$	-	-	$\pm 100$	nA
<b>On Characteristics</b>						
Gate Threshold Voltage	$V_{GS(th)}$	$V_{DS}=V_{GS}, I_D=250\mu A$	1.2	1.7	2.2	V
Drain-Source On-State Resistance	$R_{DS(ON)}$	$V_{GS}=10V, I_D=30A$	-	6.6	8	m $\Omega$
Drain-Source On-State Resistance	$R_{DS(ON)}$	$V_{GS}=4.5V, I_D=30A$	-	9.3	11	m $\Omega$
Forward Transconductance	$g_{FS}$	$V_{DS}=5V, I_D=30A$	30	-	-	S
<b>Dynamic Characteristics</b>						
Input Capacitance	$C_{iss}$	$V_{DS}=30V, V_{GS}=0V,$ $F=1.0MHz$	-	1990	-	PF
Output Capacitance	$C_{oss}$		-	470	-	PF
Reverse Transfer Capacitance	$C_{rss}$		-	14	-	PF
<b>Switching Characteristics</b>						
Turn-on Delay Time	$t_{d(on)}$	$V_{DD}=30V, I_D=2A, R_L=1\Omega$ $V_{GS}=10V, R_{GEN}=3\Omega$	-	16	-	nS
Turn-on Rise Time	$t_r$		-	8	-	nS
Turn-Off Delay Time	$t_{d(off)}$		-	45	-	nS
Turn-Off Fall Time	$t_f$		-	33	-	nS
Total Gate Charge	$Q_g$	$V_{DS}=30V, I_D=20A,$ $V_{GS}=10V$	-	31	-	nC
Gate-Source Charge	$Q_{gs}$		-	6	-	nC
Gate-Drain Charge	$Q_{gd}$		-	5	-	nC
<b>Drain-Source Diode Characteristics</b>						
Diode Forward Voltage	$V_{SD}$	$V_{GS}=0V, I_S=30A$	-	-	1.2	V
Diode Forward Current	$I_S$		-	-	80	A
Reverse Recovery Time	$t_{rr}$	$T_J = 25^\circ C, I_F = 30A$ $di/dt = 100A/\mu s$	-	35		nS
Reverse Recovery Charge	$Q_{rr}$		-	47		nC
Forward Turn-On Time	$t_{on}$	Intrinsic turn-on time is negligible (turn-on is dominated by LS+LD)				

Curve Characteristics

Fig. 1-Output Characteristics

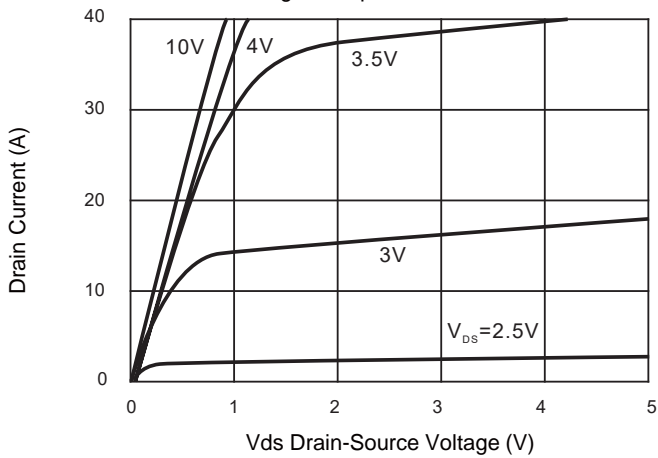

Fig. 2-Rdson-JunctionTemperature

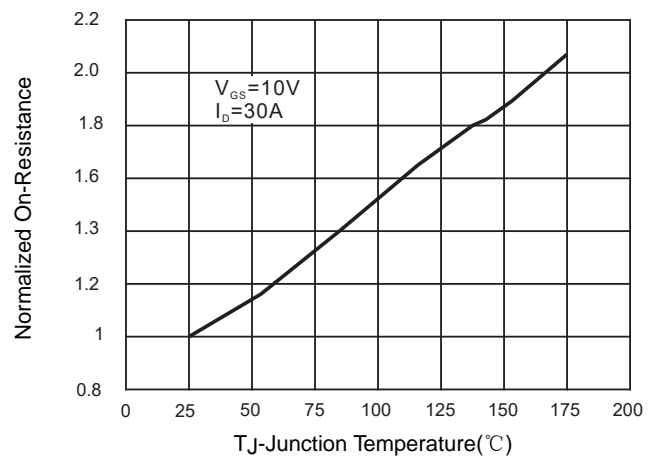

Fig. 3-Transfer Characteristics

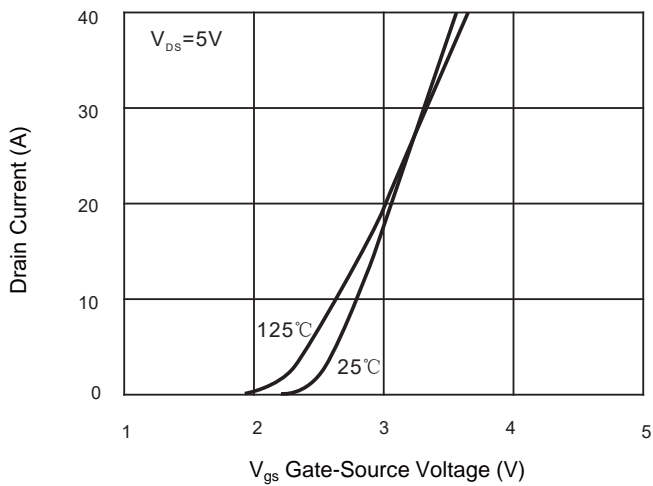

Fig. 4 - Total Gate Charge Characteristics

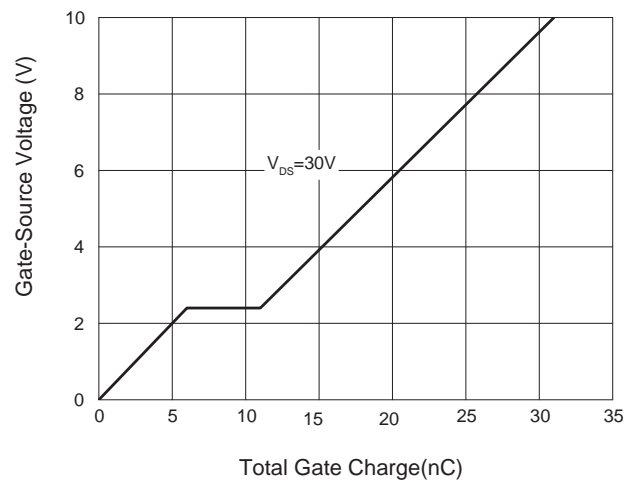

Fig. 5-Rdson- Drain Current

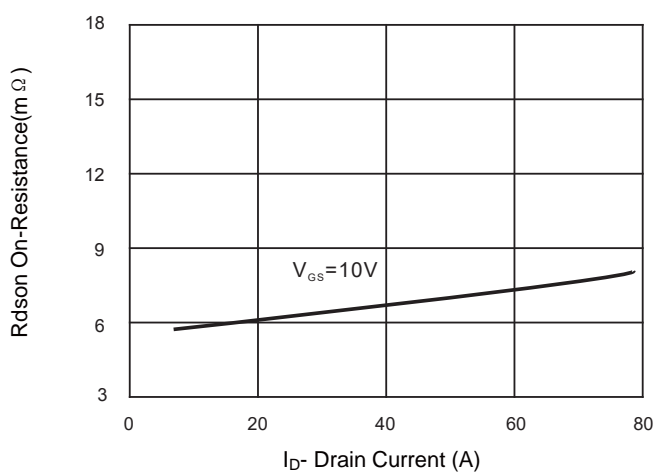
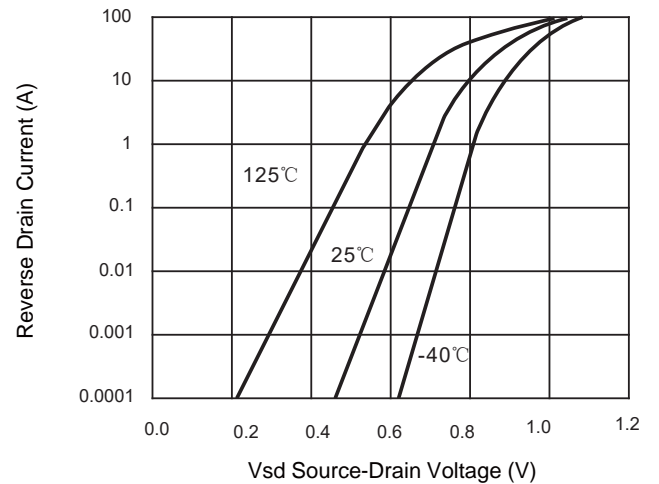

Fig. 6-Source- Drain Diode Forward



## Ordering Information

Device	Packing
Part Number-TP	Tape&Reel:2.5Kpcs/Reel

Note : Adding "-HF" Suffix For Halogen Free, eg. Part Number-TP-HF

### \*\*\*IMPORTANT NOTICE\*\*\*

**Micro Commercial Components Corp.** reserves the right to make changes without further notice to any product herein to make corrections, modifications , enhancements , improvements , or other changes . **Micro Commercial Components Corp** . does not assume any liability arising out of the application or use of any product described herein; neither does it convey any license under its patent rights ,nor the rights of others . The user of products in such applications shall assume all risks of such use and will agree to hold **Micro Commercial Components Corp** . and all the companies whose products are represented on our website, harmless against all damages. **Micro Commercial Components Corp.** products are sold subject to the general terms and conditions of commercial sale, as published at <https://www.mccsemi.com/Home/TermsAndConditions>.

### \*\*\*LIFE SUPPORT\*\*\*

MCC's products are not authorized for use as critical components in life support devices or systems without the express written approval of Micro Commercial Components Corporation.

### \*\*\*CUSTOMER AWARENESS\*\*\*

Counterfeiting of semiconductor parts is a growing problem in the industry. Micro Commercial Components (MCC) is taking strong measures to protect ourselves and our customers from the proliferation of counterfeit parts. MCC strongly encourages customers to purchase MCC parts either directly from MCC or from Authorized MCC Distributors who are listed by country on our web page cited below. Products customers buy either from MCC directly or from Authorized MCC Distributors are genuine parts, have full traceability, meet MCC's quality standards for handling and storage. **MCC will not provide any warranty coverage or other assistance for parts bought from Unauthorized Sources.** MCC is committed to combat this global problem and encourage our customers to do their part in stopping this practice by buying direct or from authorized distributors.